



LCD Controller Manual

MCT8048K Version 2.02



3 48-6

110002

TEL : 051) 332-1625

FAX : 051) 332-1628

Homepage : <http://www.mstlcd.co.kr>

E-mail : mst@mstlcd.co.kr

1. MCT8048K

,

2. MCT8048K Connector

3.

4. MCT8048K Image Overwrite

[1.] MCT8048K

Special Font

1. MCT8048K

◆ MCT8048K

- ◆ LCD Resolution : 8bit(256) Color TFT 800*480 dots
16bit Color TFT 800*480 dots

- ◆ :
KS5601

- ◆ LCD Back Light 가

- ◆ LCD Back Light : Inverter _On/Off 가

- ◆ Font : 16*16 dots
16*16 dots
8*16 dots
8*16 dots
16*16

- ◆ Image File Memory

8bit(256) Color/800*480 => 37 [Page] .

16bit Color/800*480 => 18 [Page] .

Font / , ,

◆ MCT8048K

- ◆ CPU : ARM920T 200[MHz]
- ◆ Display Type : 256 Color/16Bit Color TFT 640*480 dots
- ◆ : +12[VDC]
- ◆ LCD Backlight Inverter
- ◆ : RS-232C => 9600, 19200, 57600, 115200 [bps]

2. MCT8048K Connector

2 MCT8048K Dimensions Connector

MCT8048K Dimensions

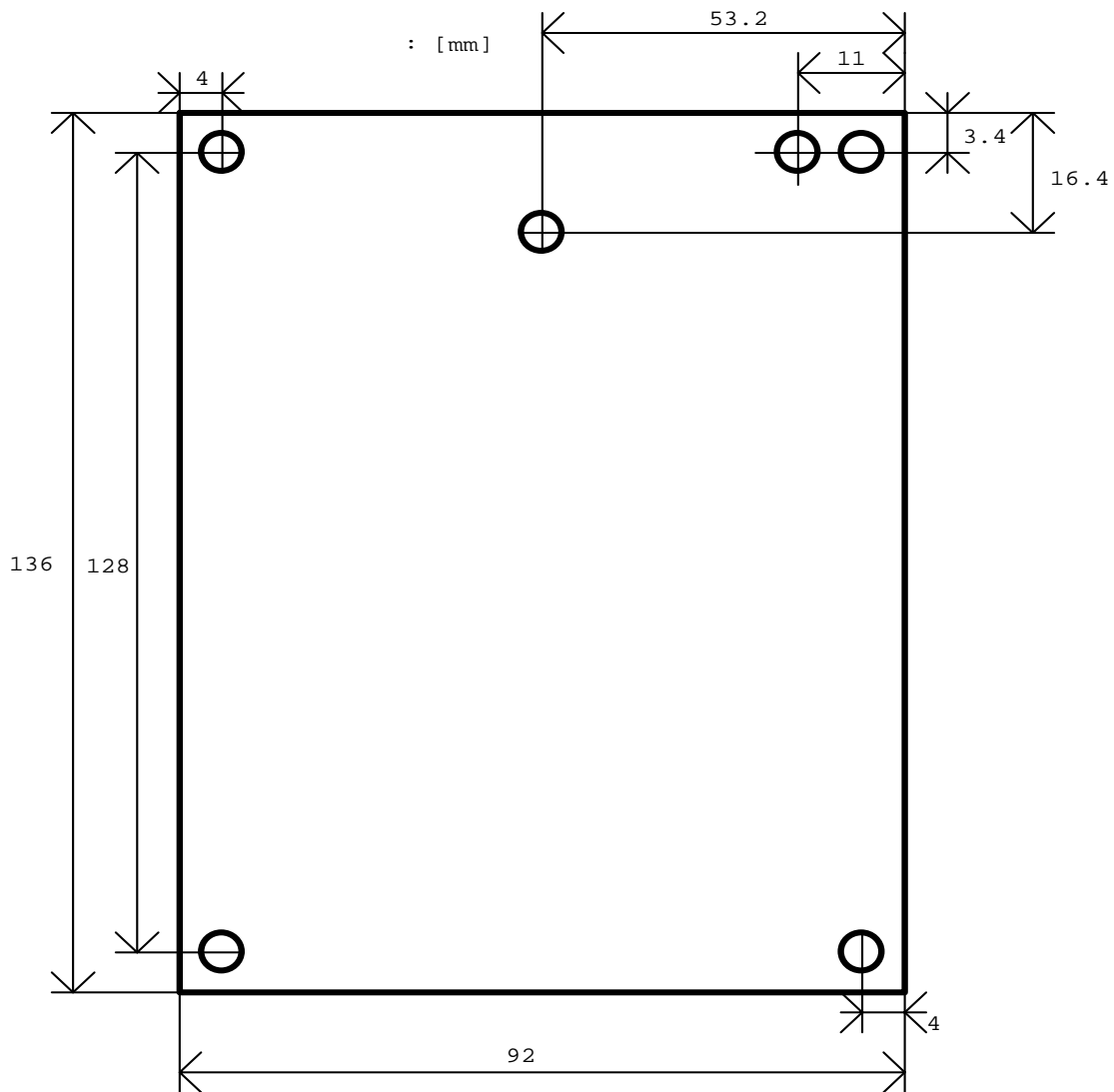

2-1. Backlight Power Connector : CN6

Pin Number	Symbol	Description
1	VCC12	+12[VDC]
2	REF	Vref
3	ON_OFF	On/OFF
4	-	-
5	GND	DC Ground

2-2. RS-232C Connector : CN1

Pin Number	Symbol	Description
1	RXD	Receive Data : LCD Controller
2	TXD	Transmit Data : LCD Controller
3	GND	DC Ground

2-3. Power Connector : CN2

Pin Number	Symbol	Description
1	VCC12	+12[VDC]
2	GND	DC Ground

2-4. Switch : S1

Pin Number	Symbol	Description
1		BaudRate
2		
3		8/16bit color
4		Reserved
5		USB download
6		Logo image display
7		LCD Backlight on/off
8		Reserved

**** BaudRate** S1-1,2 Switch on/off

S1-1	S1-2	BaudRate [bps]
ON	ON	9,600
ON	OFF	19,200
OFF	ON	57,600
OFF	OFF	115,200

**** 8/16bit Color : S1-3 Switch on/off**

S1-3	Symbol	Description
OFF	8Bit(256) Color	8Bit(256) Color
ON	16Bit Color	16Bit Color

**** USB download : S1-5 Switch on/off**

S1-5	Symbol	Description
ON		USB image download
OFF		

**** Logo image display : S1-6 Switch on/off**

S1-6	Symbol	Description
ON		Logo image display
OFF		

**** LCD Backlight on/off : S1-7 Switch on/off**

S1-7	Symbol	Description
ON		LCD Backlight on
OFF		LCD Backlight off

3.

'Esc' = 0x1b [hex]

			Parameter	
'Esc'	'K'	'0x01'		
		'0x02'		KS5601
		'0x03'		(default)
		'0x04'		
'Esc'	'E'	'0x01'		
		'0x02'		
		'0x03'		(default)
		'0x04'		
'Esc'	'P'	'0x01'		Reserved
		'0x02'		Reserved
		'0x03'		Reserved
		'0x04'		Reserved
		'0x05'		Reserved
		'0x06'		Reserved
		'0x07'		Font ON
		'0x08'		Font 가 ON
		'0x09'		Font ON
		'0x0a'		Font OFF
		'0x0b'		Reserved
		'0x0c'		Reserved
		'0x0d'		Reserved
		'0x0e'		Reserved
		'0x0f'		Reserved
		'0x10'		Reserved
		'0x11'		Reserved
		'0x12'		Reserved
		'0x13'		Reserved
'0x14'		Font 가 3 , 2		
'0x15'		Font 가 2 , 3		
'0x16'		Font 가 3 , 3		
'Esc'	'D'	'0x01'		clear

			Parameter	
		'0x02'	(X1,Y1,X2,Y2)	Text Clear (X1, Y1, X2, Y2 hex X1,X2:0x00 ~ 0x63, Y1,Y2:0x00 ~ 0x1D)
		'0x03'		Reserved
		'0x04'	(X1,Y1,X2,Y2)	Graphic clear (X1, Y1, X2, Y2 hex X1,X2:0x0000 ~ 0x031f, Y1,Y2:0x0000 ~ 0x01df)
'Esc'	'C'	'0x01'	(X,Y)	Text X,Y cursor (X,Y hex 가 :0x00 ~ 0x63 :0x00 ~ 0x1d)
		'0x02'		Reserved
		'0x03'		Reserved
		'0x04'		Reserved
		'0x05'		Reserved
		'0x06'	(X,Y)	Graphic X,Y cursor (X, Y) X:0x0000 ~ 0x031f, Y:0x0000 ~ 0x01df
'Esc'	'L'	'0x01'		LCD Back Light OFF
		'0x02'		LCD Back Light ON
'Esc'	'V'	'0x01'		LCD Back Light UP
		'0x02'		LCD Back Light DOWN
'Esc'	'G'	'0x01'	(X,Y)	Graphic _____ X:0x0000 ~ 0x031f, Y:0x0000 ~ 0x01df
		'0x02'	(X,Y)	Graphic _____ X:0x0000 ~ 0x031f, Y:0x0000 ~ 0x01df
		'0x03'	(X1,Y1,X2,Y2)	Graphic Line _____ X1,X2:0x0000 ~ 0x031f Y1,Y2:0x0000 ~ 0x01df
		'0x04'	(X1,Y1,X2,Y2)	Graphic Line _____ X1,X2:0x0000 ~ 0x031f Y1,Y2:0x0000 ~ 0x01df
		'0x05'	(X1,Y1,X2,Y2)	Graphic Rectangle _____ X1,X2:0x0000 ~ 0x031f Y1,Y2:0x0000 ~ 0x01df
		'0x06'	(X1,Y1,X2,Y2)	Graphic Rectangle _____ X1,X2:0x0000 ~ 0x031f Y1,Y2:0x0000 ~ 0x01df
		'0x07'	(X1,Y1,X2,Y2)	Graphic Rectangle _____ X1,X2:0x0000 ~ 0x031f Y1,Y2:0x0000 ~ 0x01df
		'0x08'	(X1,Y1,X2,Y2)	Graphic Rectangle _____ X1,X2:0x0000 ~ 0x031f Y1,Y2:0x0000 ~ 0x01df
		'0x09'	(X,Y,radius)	Graphic _____ X Y X:0x0000 ~ 0x031f, Y:0x0000 ~ 0x01df Radius :0x00 ~ 0xf0
		'0x0a'	(X,Y,radius)	Graphic _____ X Y X:0x0000 ~ 0x031f, Y:0x0000 ~ 0x01df Radius :0x00 ~ 0xf0

			Parameter	
		'0x0b'	(X,Y,radius)	Graphic _____ X Y X:0x0000 ~ 0x031f, Y:0x0000 ~ 0x01df Radius :0x00 ~ 0xf0
		'0x0c'	(X,Y,radius)	Graphic _____ X Y X:0x0000 ~ 0x031f, Y:0x0000 ~ 0x01df Radius :0x00 ~ 0xf0
		'0x0d'	(X,Y,a,b)	Graphic _____ X Y X:0x0000 ~ 0x031f, Y:0x0000 ~ 0x01df a :800/2 b :480/2
		'0x0e'	(X,Y,a,b)	Graphic _____ X Y X:0x0000 ~ 0x031f, Y:0x0000 ~ 0x01df a :800/2 b :480/2
		'0x0f'	(X,Y,a,b)	Graphic _____ X Y X:0x0000 ~ 0x031f, Y:0x0000 ~ 0x01df a :800/2 b :480/2
		'0x10'	(X,Y,a,b)	Graphic _____ X Y X:0x0000 ~ 0x031f, Y:0x0000 ~ 0x01df a :800/2 b :480/2
'Esc'	'A'	'0x01'		Reset (MCT8048K Rebooting)
		'0x02'		LCD Back Light
		'0x03'		Echo '0x06' Send
		'0x04'		User font display 16Byte Send Image data가 16Byte dummy data 16Byte
		'0x05'	(l)	256 Mode Text color , l:0x00~0xff 16Bit Color mode l:R.G.B [Bytes]. R.G.B =>R:0x00~0xff; G:0x00~0xff; B:0x00~0xff;
		'0x06'	(l)	Text background color , l:0x00~0xff 16Bit Color mode l:R.G.B [Bytes].
		'0x07'		Reserved
		'0x08'	(l)	Text overlay on
		'0x09'	(l)	Text overlay off
		'0x0a'	(l)	Image overlay on
		'0x0b'	(l)	Image overlay off
'0x0c'	(l)	Image overlay background color setting		
'Esc'	'I'	'0x01'	(l)	Image One page draw (l 0x00~0x2f : 256color, 0x00~0x17 :16bit)
		'0x02'		Reserved
		'0x03'		Reserved
		'0x04'	(X,Y)	Reserved

			Parameter	
		'0x05'	(I,J)	Reserved
		'0x06'	(I,X1,Y1,X2,Y2)	I: Page Number, X1,Y1(start point), X2,Y2(end point) 2byte
		'0x07'	(I,X1,Y1,X2,Y2)	I: Page Number, X1,Y1 - image start point X2,Y2 - image size
'Esc'	'T'	'0x01'		Reserved
		'0x02'		Reserved
		'0x03'		Touch start
		'0x04'		Touch end
		'0x05'		Touch start -> touch panel down -> 320,240 (ASCII 7byte) serial
		'0x06'		Touch panel down -> 320,240 (ASCII 7byte) serial -> touch panel up -> 0xff serial
		'0x07'		'0x05' 800*480 (ASCII 9byte)
		'0x08'		'0x06' 800*480 (ASCII 9byte)
		'0x09'		Reserved
		'0x0a'		Reserved
		'0x0b'		Touch head on 0x02
		'0x0c'		Touch head off
		'0x0d'		Reserved
		'0x0e'		Reserved
		'0x0f'		Reserved
		'0x10'		Reserved
'0x11'		Touch calibration		

4. MCT8048K Image Overwrite

Image Overwrite Application Program

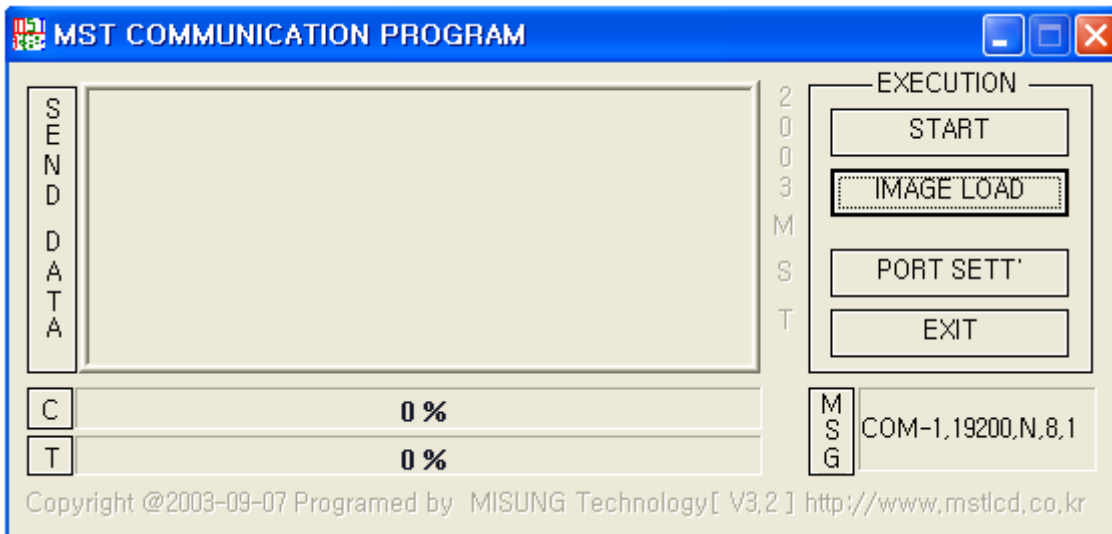

MCT8048K Image display ,
 Image page Overwrite .

MCT8048K PC Serial Cable

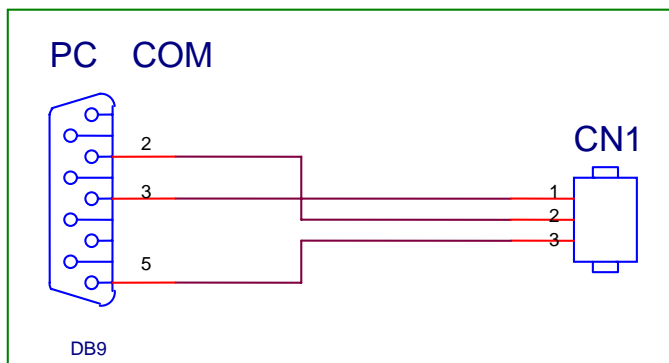
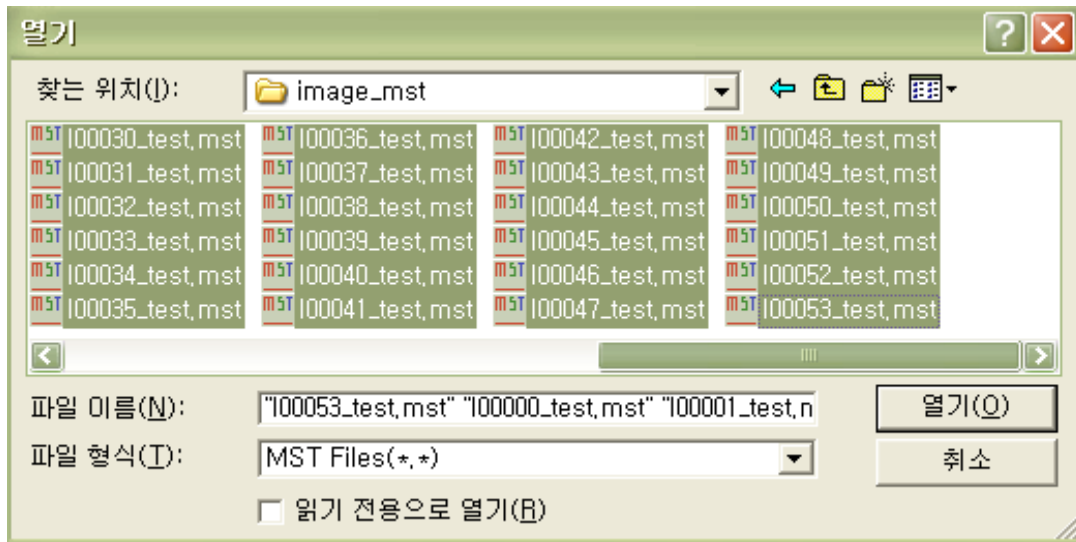
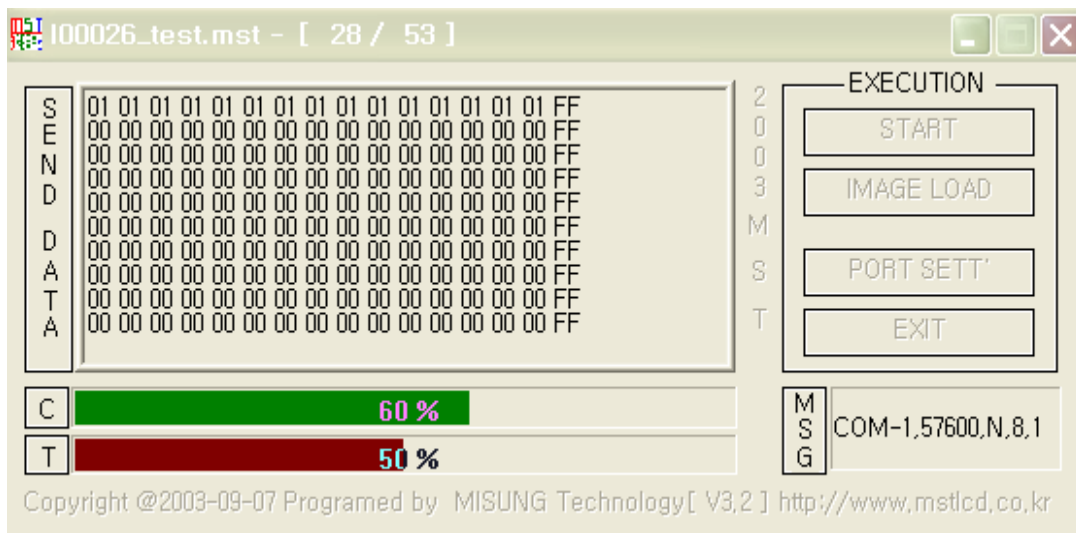

image , 'IMAGE LOAD'



, 'START' MCT8048K Overwrite



Bar Bar Download
, Bar
Bar 가 '100%' Image Overwrite

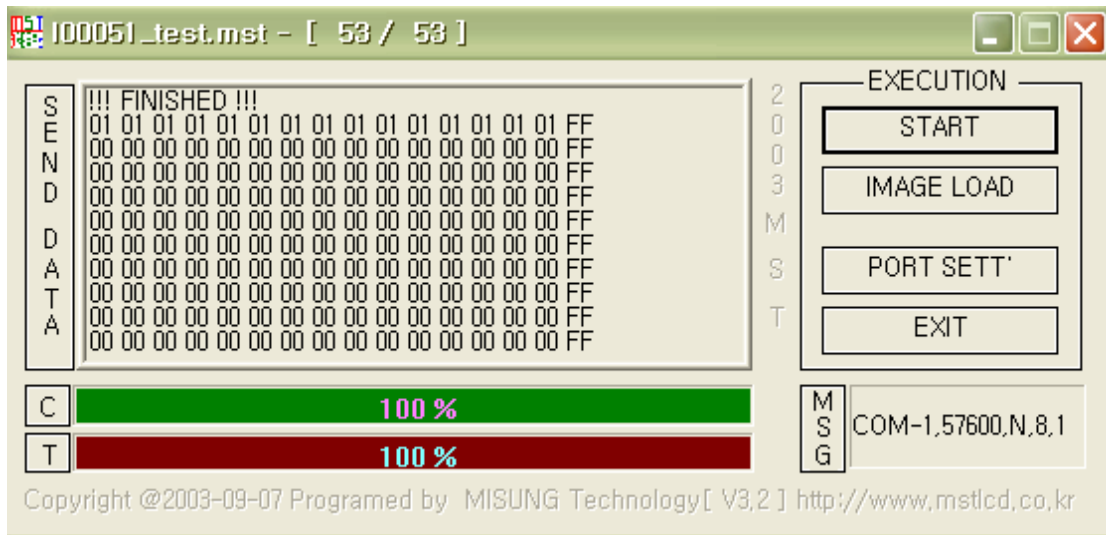

'IMAGE LOAD'

Image

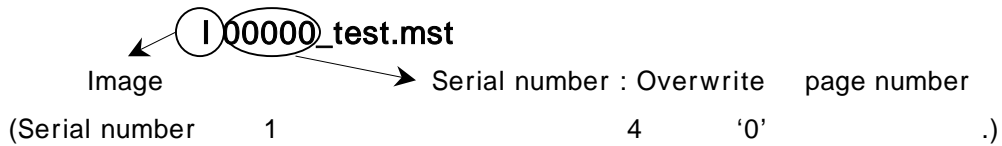

Ex) 1 page Overwrite file I00001_test.mst

[1.] MCT8048K

Special Font

< 1- 1 > MCT8048K (Special Font)

Special < 1- 1 >

	0x00	0x01	0x02	0x03	0x04	0x05	0x06	0x07	0x08	0x09	0x0A	0x0B	0x0C	0x0D	0x0E	0x0F
0x00		☎	☎	☎	☎	☎	☎	☎	No.	Co.	TM.	am.		FM.	Tel.	
0x10	I	II	III	IV	V	VI	VII	VIII	IX	X	ℓℓ	mℓ	dℓ	ℓ	kℓ	cc
0x20	mm ³	cm ³	m ³	km ³	fm	nm	μm	mm	cm	km	mm ²	cm ²	m ²	km ²	ha	ℓg
0x30	m ^g	k ^g	kt	cal	kcal	dB	m ³ /s	m ³ /s	ps	ns	μs	ms	pV	nV	μV	mV
0x40	kV	MV	PA	nA	μA	mA	KA	FW	nW	μW	mW	kW	MW	Hz	kHz	MHz
0x50	GHz	THz	Ω	kΩ	MΩ	PF	nF	μF	mol	cd	rad	rad ² /s	rad ³ /s	sr	Pa	kPa
0x60	MPa	GPa	Wb	Im	lx	Bq	Gy	Sv	°/kg	㉿	㊀	㊁	㊂	㊃	㊄	㊅
0x70	㊆	㊇	㊈	㊉	㊊	㊋	㊌	㊍	㊎	㊏	㊑	㊒	㊓	㊔	㊕	㊖
0x80	㊗	㊘	㊙	㊚	㊛	㊜	㊝	㊞	㊟	㊠	㊡	㊢	㊣	㊤	㊥	㊦
0x90	㊧	㊨	㊩	㊪	㊫	㊬	㊭	㊮	㊯	㊰	㊱	㊲	㊳	㊴	㊵	㊶
0xA0	㊷	㊸	㊹	㊺	㊻	㊼	㊽	㊾	㊿	①	②	③	④	⑤	⑥	⑦
0xB0	⑧	⑨	⑩	⑪	⑫	⑬	⑭	⑮	⑯	⑰	⑱	⑲	⑳	㉑	㉒	㉓
0xC0	㉔	㉕	㉖	㉗	㉘	㉙	㉚	㉛	㉜	㉝	㉞	㉟	㊀	㊁	㊂	㊃
0xD0	㊄	㊅	㊆	(a)	(b)	(c)	(d)	(e)	(f)	(g)	(h)	(i)	(j)	(k)	(l)	(m)
0xE0	(n)	(o)	(p)	(q)	(r)	(s)	(t)	(u)	(v)	(w)	(x)	(y)	(z)	(1)	(2)	(3)
0xF0	(4)	(5)	(6)	(7)	(8)	(9)	(10)	(11)	(12)	(13)	(14)	(15)				

< 1 - 1 >

3 48-6

110002

TEL : 051) 332-1625

FAX : 051) 332-1628

Homepage : <http://www.mstlcd.co.kr>

E-mail : mst@mstlcd.co.kr